



2013/03/27

DTA Series Temperature Controller Instruction Sheet

Thank you very much for purchasing DELTA A Series. Please read this instruction sheet before using your A series to ensure proper operation and please keep this instruction sheet handy for quick reference.

■ Precaution

 DANGER! Caution! Electric Shock!

1. Do not touch the AC terminals while the power is supplied to the controller to prevent an electric shock.
2. Make sure power is disconnected while checking the unit inside.
3. The symbol  indicates that this Delta A Series Temperature Controller is protected throughout by DOUBLE INSULATION or REINFORCED INSULATION (equivalent to Class II of IEC 536).

 WARNING!

This controller is an open-type temperature controller. Make sure to evaluate any dangerous application in which a serious human injury or serious property damage may occur.

1. Always use recommended solder-less terminals: Fork terminal with isolation (M3 screw, width is 7.0mm, hole diameter 3.2mm).
Screw size: M3 x 6.5 (With 6.8 x 6.8 square washer).
Recommended tightening torque: 0.4 N.m (4kgf.cm).
Applicable wire: Solid/twisted wire of 2 mm², 12AWG to 24AWG.
Please be sure to tighten them properly.
2. Do not allow dust or foreign objects to fall inside the controller to prevent it from malfunctioning.
3. Never modify or disassemble the controller.
4. Do not connect anything to the "No used" terminals.
5. Make sure all wires are connected to the correct polarity of terminals.
6. Do not install and/or use the controller in places subject to:
 - Dust or corrosive gases and liquid.
 - High humidity.
 - High radiation.
 - Vibration and shock.
 - High voltage and high frequency
7. Must turn power off when wiring and changing a temperature sensor.
8. Be sure to use compensating wires that match the thermocouple types when extending or connecting the thermocouple wires.
9. Please use wires with resistance when extending or connecting a platinum resistance thermometer (RTD).
10. Please keep the wire as short as possible when wiring a platinum resistance thermometer (RTD) to the controller and please route power wires as far as possible from load wires to prevent interference and induced noise.
11. This controller is an open-type unit and must be placed in an enclosure away from high temperature, humidity, dripping water, corrosive materials, airborne dust and electric shock or vibration.
12. Please make sure power cables and signals from instruments are all installed properly before energizing the controller, otherwise serious damage may occur.
13. Please do not touch the terminals in the controller or try to repair the controller when power is applied to prevent an electric shock.
14. Wait at least one minute after power is disconnected to allow capacitors to discharge, and please do not touch any internal circuit within this period.
15. Do not use acid or alkaline liquids for cleaning. Please use a soft, dry cloth to clean the controller.
16. This instrument is not furnished with a power switch or fuse. Therefore, if a fuse or power supply switch is required, install the protection close to the instrument.
Recommended fuse rating: Rated voltage 250 V, Rated current 1 A.
Fuse type: Time-lag fuse
Note: This controller does not provide overcurrent protection. Use of this product requires that suitable overcurrent protection device(s) must be added to ensure compliance with all relevant electrical standards and codes. (Rated 250 V, 15 Amps max). A suitable disconnecting device should be provided near the controller in the end-use installation.

■ Ordering Information

DTA -

① ② ③ ④ ⑤

① Series	DTA: Delta A Series Temperature Controller	
② Panel Size (W × H)	4848: 1/16 DIN W48 × H48mm 4896: 1/8 DIN W48 × H96mm 7272: W72 × H72mm	9648: 1/8 DIN W96 × H48 9696: 1/4 DIN W96 × H96mm
③ Output Selection	R: Relay output, SPDT (SPST: 1/16 DIN size), 250VAC, 5A V: Voltage Pulse output, 14V+10% ~ -20% (Max. 40mA) C: Current output, 4 ~ 20mA	
④ Communication (Optional)	0: No interface 1: RS-485	
⑤ Current Transformer (CT) Function (Optional)	None: No CT function (Current transformer is not provided) T: Current transformer is provided (only DTA7272 series support this function)	

■ Display, LED & Pushbuttons

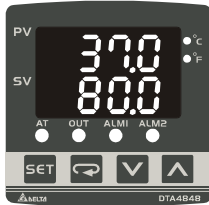

- **PV Display:** to display the process value or parameter type.
- **SV Display:** to display set point, parameter operation read value, manipulated variable or set value of the parameter.
- **AT:** flashes when the Auto-tuning operation is ON.
- **OUT:** lights when the output is ON.

- **SET** : **Function key.**
 1. Press this key to select the desired function mode.
 2. Press this key to confirm a setting value.
- **Mode key.** Press this key to set parameters within each function mode.
- **°C, °F : Temperature unit LEDs.** °C LED lights when this parameter is configured for Celsius and °F LED lights if configured for Fahrenheit.
- **ALM1 / ALM2 : Alarm output LED.** The ALM1 / ALM2 LED lights when Alarm 1 or Alarm 2 output is ON.
- **Up key.** Press this key to increase values displayed on the SV display. Hold down this key to speed up the incremental action.
- **Down key.** Press this key to decrease values displayed on the SV display. Hold down this key to speed up the decrements.

■ Specifications

Input voltage	100 ~ 240VAC 50/60Hz
Operation voltage range	85% to 110% of rated voltage
Power consumption	5VA max.
Display method	7-segment digit LED Display Process value (PV): Red color, Set point (SV): Green color
Sensor type	Thermocouple: K, J, T, E, N, R, S, B, U, L, Txx 3-wire Platinum RTD: Pt100, JPt100 Copper resistor: Cu50
Control mode	PID, ON/OFF control or Manual tuning
Control output	Relay output:(resistive load): SPDT (SPST: 1/16 DIN size), 250VAC, 5A Voltage Pulse output: DC 14V, Max. load current 40mA Current output: 4 to 20mADC (Load resistance: Max. 600Ω)
Display accuracy	0.1% of measuring range
Sampling rate	500 msec/per scan
Vibration resistance	10 to 55Hz, 10m/s ² for 10min, each in X, Y and Z directions
Shock resistance	Max. 300m/s ² , 3 times in each 3 axes, 6 directions
Ambient temperature	0°C ~ +50°C

Storage temperature	-20°C ~ +65°C
Relative humidity	35% ~ 80% (non-condensing)
Altitude	2,000m or less
Installation environment	Installation Category II, Pollution Degree 2. Conforming to EN61010-1
Panel protection level	IP65

■ Parameters List

1. Operation Mode: Perform per the settings of related control parameters

LED Display	Explanation	Default
r-S	RUN/STOP: Control setting begins. Run (rUN) or Stop (StOP) mode on the SV display.	RUN
AL1H	ALARM1 HIGH: Upper-limit alarm 1	4.0 °C
AL1L	ALARM1 LOW: Lower-limit alarm 1	4.0 °C
AL2H	ALARM2 HIGH: Upper-limit alarm 2	4.0 °C
AL2L	ALARM2 LOW: Lower-limit alarm 2	4.0 °C
LoC	Setting lock: Lock 1 (LoC1), Lock 2 (LoC2) or OFF (OFF) on the SV display. Lock 1 mode can lock all settings and Lock 2 mode only can lock others than SV value. When OFF mode is selected, the Lock function will be OFF. If you press SET and ← key simultaneously, the "Lock" status can be released and the controller will be back to the previous display.	OFF
OUT	OUT: Output value display and output value adjustment in manual tuning control (This function is not available in ON/OFF control or Auto-tuning setting)	0
CT	CT: In case of using an external current transformer (CT), the controller displays the current value being measured by CT, if the control output is ON	Read only

2. Regulation Mode: Set the control parameters

LED Display	Explanation	Default
AT	AT: Auto-tuning setting. When AT key is set to ON (ON), the execution of the PID auto-tuning function is automatically started. (PID control)	OFF
P	P: Proportional Band (PID control)	47.6
I	I: Integral Time (PID control)	260
d	D: Derivative Time (PID control)	41
Pdof	Pdof: Offset output when P or PD control function is ON. (PID control and Ki=0)	0
ioF	ioF: Default value of integral volume when PID control function is ON and integral time constant is not equal to 0(zero). AT can automatically set this parameter. (PID control and Ki≠0)	0
HTS	HTS: Set Heating hysteresis when ON/OFF control function is ON.	0
CTS	CTS: Set Cooling hysteresis when ON/OFF control function is ON.	0
HTPd	HTPd: PID heating control cycle setting (PID control)	Output Selection: V: 4 sec. R: 20 sec.
CLPd	CLPd: PID cooling control cycle setting (PID control)	
tPof	TPOF: Regulate temperature deviation value	0
CrHc	CRHI: Regulate 20mA output deviation value (1unit = 0.1mA)	0
CrLo	CRLO: Regulate 4mA output deviation value (1unit = 0.1mA)	0

3. Initial Setting Mode: Initial settings of the controller and communication parameters

LED Display	Explanation	Default
InPt	INPUT: Select input temperature sensor type (Please refer to the contents of the "Temperature Sensor Type and Temperature Range" for detail)	PT2
tPUu	UNIT: Temperature display unit, °C (C) and °F (F)	°C
tP-H	T-HIGH: Upper limit for temperature range	500.0

LED Display	Explanation	Default
EP-L	T-LOW: Lower limit for temperature range	-20.0
Ctrl	CONTROL: Control method setting on the SV display: PID (PID), ON/OFF control (ONOFF), or manual tuning (MANU)	PID
S-HC	SWITCH: Select Heating (HEAT) or Cooling (COOL) action	HEAT
AL1	AL1 SET: Alarm 1 setting (See explanations in "Alarm Outputs" section.)	0
AL2	AL2 SET: Alarm 2 setting (See explanations in "Alarm Outputs" section.)	0
C-SL	C SELECT : ASCII, RTU communication formats selection (Displayed when using serial communication)	ASCII
CoSW	C WE: Write-in function disable/enable (Displayed when using serial communication)	OFF
C-no	C NO: Address setting (Displayed when using serial communication)	1
bPS	BPS: Baud rate setting (Displayed when using serial communication)	9,600
LEN	LENGTH: Data length setting (Displayed when using serial communication)	7
Prty	PARITY: Parity bit setting (Displayed when using serial communication)	E
StoP	STOP BIT: Stop bit setting (Displayed when using serial communication)	1

Note: Alarm values should be set in the initial setting mode so AL1H, AL1L, AL2H and AL2L would display in operation mode.

■ Operation

There are three modes of operation: operation, regulation and initial setting. When power is applied, controller gets into the operation mode. Press the **SET** key to switch to regulation mode. If the **SET** key is pressed for more than 3 seconds, controller will switch to the initial setting mode. Pressing the **SET** key while in the regulation mode or initial setting mode, forces the controller to return to the operation mode.

PV/SV: Sets the temperature set point and displays the temperature process value. Use the **▲** and **▼** keys to set the temperature set point.

Setting method: While in any function mode, press the **↻** key to select the desired function and use the **▲** and **▼** keys to change settings. Press **SET** key to save the changes.

The next flow chart shows how to switch for settings and internal functions:



Regulation Mode	Operation Mode	Initial Setting Mode
At Auto-tuning (In PID control and RUN mode) Press ↻	1234 Use ▼ ▲ to set temperature of target Press ↻	CnPt Set input type Press ↻
P Set PID PB (In PID control) Press ↻	r-S Control setting RUN or STOP Press ↻	EPUn Set temperature unit Press ↻
Ti Set PID Ti (In PID control) Press ↻	AL1H Upper-limit alarm 1 (This parameter is available only when ALA1 function enables) Press ↻	EP-H Set upper-limit of temperature range Press ↻
Td Set PID Td (In PID control) Press ↻	AL1L Lower-limit alarm 1 (The parameter is available only when ALA1 function enables) Press ↻	EP-L Set lower-limit of temperature range Press ↻

Regulation Mode	Operation Mode	Initial Setting Mode
Pdof or CoF P/PD control offset setting (When PID control is ON and Ki=0, set the value of Pdof; if Ki≠0, AT will automatically set the value of lof) Press ▾	AL2H Upper-limit alarm 2 (This parameter is available only when ALA2 function enables) Press ▾	Ctrl Select control mode Press ▾
HtS or CtS Heating/Cooling hysteresis (In ON-OFF control) Press ▾	AL2L Lower-limit alarm 2 (This parameter is available only when ALA2 function enables) Press ▾	S-HC Select Heating/Cooling functions Press ▾
HtPd or CLPd Set Heating/Cooling control cycle (In PID control) Press ▾	LoL Setting lock mode Press ▾	ALA1 Alarm 1 setting Press ▾
EPoF Regulate temperature deviation value Press ▾	oUe Output value display and adjust Press ▾	ALA2 Alarm 2 setting Press ▾
CrHc Regulate 20mA output deviation value (Display when in current output) Press ▾	CE CT function is selected In case of using an external CT, the controller displays the current value being measured by CT, if the control output is ON. Press return to temperature display	C-SL ASCII, RTU communication formats selection Press ▾
CrLo Regulate 4mA output deviation value (Displayed when in current output) Press return to auto-tuning setting		CoSH Write-in function disable/enable (Displayed when using serial communication) Press ▾
		C-no Address setting (Displayed when using serial communication) Press ▾
		bPS Baud rate setting (Displayed when using serial communication) Press ▾
		LEn Date length setting (Displayed when using serial communication) Press ▾
		Prty Parity bit setting (Displayed when using serial communication) Press ▾
		StoP Stop bit setting (Displayed when using serial communication) Press return to input type

■ Heating and Cooling Control

Temperature control is achieved either by heating or by cooling. The heating function starts when the process temperature (PV) is going down, and the cooling function when the temperature is getting high. It is impossible to operate both functions simultaneously in this controller.

Temperature Sensor Type & Temperature Range

Input temperature sensor type	Register value	LED display	Temperature range
Platinum resistance (Pt100) type 3	15	Pt3	0.0 ~ 100.0°C
Platinum resistance (Pt100) type 2	14	Pt2	-20.0 ~ 500.0°C
Platinum resistance (Pt100) type 1	13	Pt1	-200 ~ 600°C
Platinum resistance (JPt100) type 2	12	JPt2	0.0 ~ 100.0°C
Platinum resistance (JPt100) type 1	11	JPt1	-20.0 ~ 400.0°C
Copper resistor (Cu50) type2	20	Cu2	-50.0 ~ 150.0°C
Copper resistor (Cu50) type1	19	Cu1	-50 ~ 150°C
Thermocouple (TC) B type	10	b	100 ~ 1,800°C
Thermocouple (TC) S type	9	s	0 ~ 1,700°C
Thermocouple (TC) R type	8	r	0 ~ 1,700°C
Thermocouple (TC) N type	7	n	-200 ~ 1,300°C
Thermocouple (TC) E type	6	e	0 ~ 600°C
Thermocouple (TC) T type 2	5	t2	-20.0 ~ 400.0°C
Thermocouple (TC) T type 1	4	t1	-200 ~ 400°C
Thermocouple (TC) J type 2	3	j2	-20.0 ~ 400.0°C
Thermocouple (TC) J type 1	2	j1	-100 ~ 850°C
Thermocouple (TC) K type 2	1	k2	-20.0 ~ 500.0°C
Thermocouple (TC) K type 1	0	k1	-200 ~ 1300°C
Thermocouple (TC) L type	16	L	-200 ~ 850°C
Thermocouple (TC) U type	17	U	-200 ~ 500°C
Thermocouple (TC) Txk type	18	tXk	-200 ~ 800°C

Input Error Indication

Set value	Temperature sensor not connected	Measured temperature value exceeds temperature range	Unknown input
PV	no	over	Err
SV	Cont		CPt

Alarm Outputs

There are up to two groups of alarm outputs and each group allows 13 alarm types in the initial setting mode. The alarm output is activated whenever the process temperature value (PV) is getting higher or lower than the set point of alarm limit.

Set value	Alarm type	Alarm output operation
0	Alarm function disabled	Output OFF
1	Deviation upper- and lower-limit: This alarm output operates when PV value is higher than the setting value SV + (AL-H) or lower than the setting value SV - (AL-L).	
2	Deviation upper-limit: This alarm output operates when PV value is higher than the setting value SV + (AL-H).	
3	Deviation lower-limit: This alarm output operates when PV value is lower than the setting value SV- (AL-L).	

Set value	Alarm type	Alarm output operation
4	Reverse deviation upper- and lower-limit: This alarm output operates when PV value is in the range of the setting value SV + (AL-H) and SV - (AL-L).	
5	Absolute value upper- and lower-limit: This alarm output operates when PV value is higher than the setting value AL-H or lower than setting value AL-L.	
6	Absolute value upper-limit: This alarm output operates when PV value is higher than the setting value AL-H.	
7	Absolute value lower-limit: This alarm output operates when PV value is lower than the setting value AL-L.	
8	Deviation upper- and lower-limit with standby sequence: This alarm output operates when PV value reaches set value (SV value) and the value is higher than the setting value SV + (AL-H) or lower than the setting value SV - (AL-L).	
9	Deviation upper-limit with standby sequence: This alarm output operates when PV value reaches set value (SV value) and the reached value is higher than the setting value SV + (AL-H).	
10	Deviation lower-limit with standby sequence: This alarm output operates when PV value reaches the set value (SV value) and the reached value is lower than the setting value SV - (AL-L).	
11	Hysteresis upper limit alarm output: this alarm output operates if PV value is higher than the setting value SV + (AL-H). This alarm output is OFF when PV value is lower than the setting value SV + (AL-L).	
12	Hysteresis lower limit alarm output: this alarm output operates if PV value is lower than the setting value SV - (AL-L). This alarm output is OFF when PV value is higher than the setting value SV - (AL-H).	
13	CT alarm output: This alarm operates when the current measured by transformer (CT) is lower than AL-L or higher than AL-H (This alarm output is available only for the controller with current transformer).	

Note: AL-H and AL-L include AL1H, AL2H and AL1L, AL2L.

With standby sequence: Meaning that the alarm output would be temporarily disabled until the PV value reaches the set value. Then, the alarm output will operate.

■ Current Transformer (CT) Function

The Current Transformer (CT) function is used with the alarm output. When using a current transformer (CT) with the controller, change the corresponding alarm output mode to mode 13 (alarm output set value is 13), then turn to operation mode and set the current lower-limit and current upper-limit. You can set current alarm range between 0.5A ~ 30A, display resolution is 0.1A and measure accuracy is +/- 0.5A.

■ Communication Parameters List

Controller offers a RS-485 port for serial communication.

- Supporting transmission speed: 2,400, 4,800, 9,600, 19,200, 38,400bps
- Communication protocol: Modbus (ASCII)
- Non-supported formats: 7, N, 1 or 8, O, 2 or 8, E, 2
- Available communication address: 1 to 255, 0 is broadcast address
- Function code: 03H to read the contents of register (Max. 3 words); 06H to write 1 (one) word into register.

Address	Content	Explanation
4700H (R)	Process value (PV)	Measuring unit is 0.1, updated one time in 0.5 second
4701H	Set point (SV)	Unit: 0.1 (°C or °F)
4702H	Upper-limit alarm 1	
4703H	Lower-limit alarm 1	
4704H	Upper-limit alarm 2	
4705H	Lower-limit alarm 2	
4706H	Upper-limit of temperature range	The data content should not be higher than the temperature range

Address	Content	Explanation
4707H	Lower-limit of temperature range	The data content should not be lower than the temperature range
4708H	PB Proportional band	0.1 ~ 999.9, Unit: 0.1
4709H	Ti Integral time	0 ~ 9,999
470AH	Td Derivative time	0 ~ 9,999
470BH	Heating/Cooling hysteresis	0 ~ 9,999
470CH	Regulate 20mA current output deviation	-100 ~ 54 (1 unit = 0.1mA)
470DH	Regulate 4mA current output deviation	-39 ~ 100 (1 unit = 0.1mA)
470EH	Default value of integral volume	0 ~ 100%
4710H	Input temperature sensor type	Please refer to the contents of the "Temperature Sensor Type and Temperature Range" for detail
4711H	Control method	0: PID (default), 1: ON/OFF, 2: manual tuning
4712H	Heating/Cooling control cycle	1 ~ 99 second
4713H	Proportional control offset error value	0% ~100%
4714H	Temperature regulation value	-999 ~ 999, Unit: 0.1
4715H	Alarm 1 type	Please refer to the contents of the "Alarm Outputs" for detail
4716H	Alarm 2 type	Please refer to the contents of the "Alarm Outputs" for detail
4717H	Temperature unit display selection	°C : 1 (default), °F : 0
4718H	Heating/Cooling control Selection	Heating: 0 (default), Cooling: 1
4719H	Control Run/Stop setting	Run: 1 (default), Stop: 0
471AH	Communication write-in selection	Communication write in disabled: 0 (default), Communication write in enabled: 1
471BH	Software version	V1.00 indicates 0 x 100
471CH	Read LED status	b2: °F, b3: °C, b4: AL2, b5: AL1, b6: OUT, b7: AT
471DH	Read KEY status	b0: SET, b1: Select, b2: Up, b3: Down
471EH	Read output amount	Unit: %
4729H	AT Setting	OFF: 0 (default), ON:1
472AH	Write output amount	Available on "manual control" only
472BH (R)	Code 0	Normal operation (No error)
	Code 1	Initial process
	Code 2	Initial status (Temperature is not stable)
	Code 3	Temperature sensor is not connected
	Code 4	Temperature sensor input error
	Code 5	Measured temperature value exceeds the temperature range
	Code 6	No Int. error
	Code 7	EEPROM Error
4731H	Read / Write lock status	0: No Lock, 1: Lock1, 11: Lock2, 21: Lock3
4732H	Event input switch	0: Event disable, 1: SV switch, 2: Run/Stop
4733H	CT monitor value	Unit is 0.1A

Note: R refers to "read only" value

■ Default Communication Response Setting

Write hex value 1234 into register at 471BH and 1234 again into register at 4724H. Re-power DTA to complete the default setting.

■ Communication Protocol

Command code to read N words: 03H. The maximum value of N is 3.

For example, in order to read two words from controller 01 (address 01H) at starting data address 4700H, the command in ASCII mode is:

ASCII mode:

Command message:		Response message:	
STX	':'	STX	':'
ADR1	'0'	ADR1	'0'
ADR0	'1'	ADR0	'1'
CMD1	'0'	CMD1	'0'
CMD0	'3'	CMD0	'3'
Starting data address	'4'	Number of data (count by byte)	'0'
	'7'		'4'
	'0'	Content of start address 4700H	'0'
	'0'		'1'
'0'	'9'		
'0'	'0'		
Number of data (counted by word)	'0'	Content of start address 4701H	'0'
	'0'		'0'
	'2'		'0'
LRC CHK 1	'B'		LRC CHK 1
LRC CHK 0	'3'	LRC CHK 0	'7'
END 1	CR	END 1	CR
END 0	LF	END 0	LF

LRC check:

LRC check is the added sum from "Address" to "Data content". For example, 01H + 03H + 47H + 00H + 00H + 02H = 4DH, then take the complementary of 2, B3H.

Command code to write 1 word: 06H

For example, in order to write 1000 (03E8H) in controller 01 (comm. address 01H) at the starting data address 4701H, the command in ASCII mode is:

ASCII mode:

Command message:		Response message:	
STX	':'	STX	':'
ADR1	'0'	ADR1	'0'
ADR0	'1'	ADR0	'1'
CMD1	'0'	CMD1	'0'
CMD0	'6'	CMD0	'6'
Starting data address	'4'	Starting data address	'4'
	'7'		'7'
	'0'		'0'
	'1'		'1'
Data content	'0'	Data content	'0'
	'3'		'3'
	'E'		'E'
	'8'		'8'
LRC CHK 1	'C'	LRC CHK 1	'C'
LRC CHK 0	'6'	LRC CHK 0	'6'
END 1	CR	END 1	CR
END 0	LF	END 0	LF

Terminal Identification

DTA4848

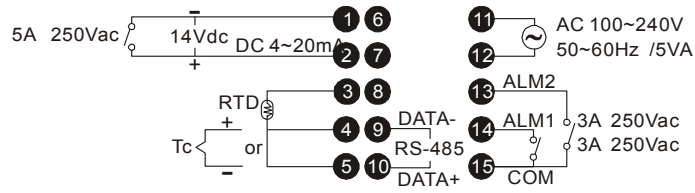

DTA7272

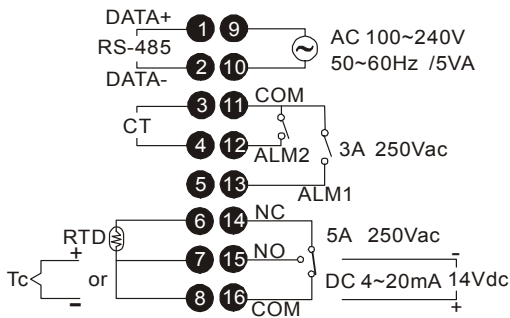

DTA4896/DTA9648/DTA9696

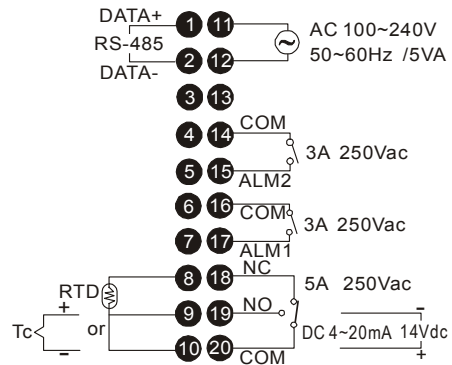

Mounting

Step 1. Insert the controller through the panel cutout.

Step 2. Insert the mounting bracket into the mounting groove at the top and bottom of the controller and push the mounting bracket forward until the bracket stops at panel wall.

Step 3. Insert and tighten screws on bracket to secure the controller in place. (The screw torque should be 0.8kgf-cm to 1.5kgf-cm)

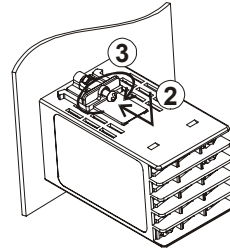
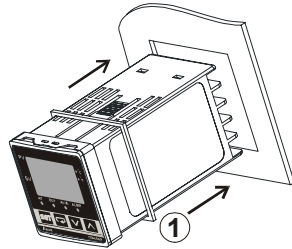

Mounting Bracket Installation

1.

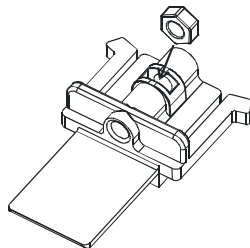

2.

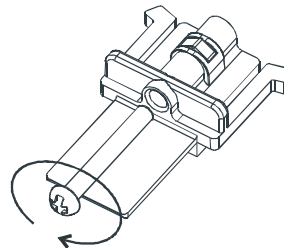

■ Panel Cutout & External Dimensions

1. Panel wall thickness should range from 1mm to 8mm
2. Provide at least 90 mm clearance around the controller for proper ventilation. (Dimensions are in millimeter and (inch))

DTA4848

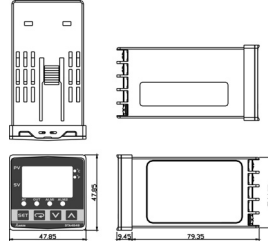
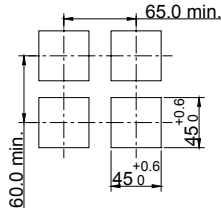

DTA4896

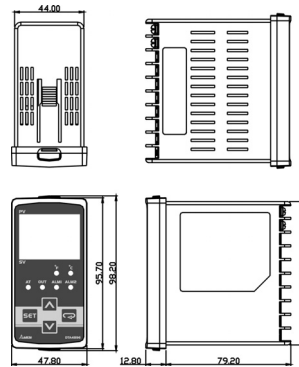
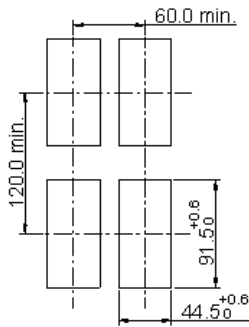

DTA9648

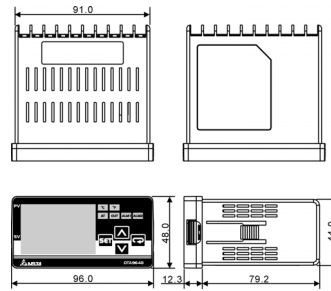
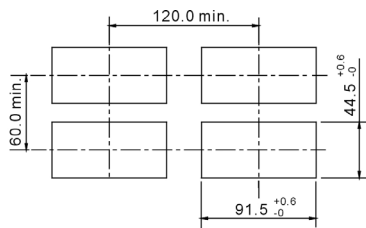

DTA7272

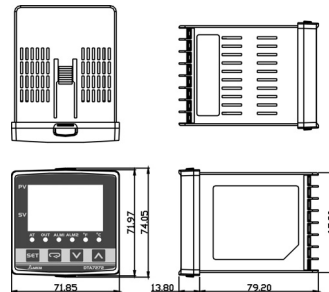
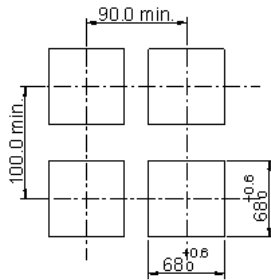

DTA9696

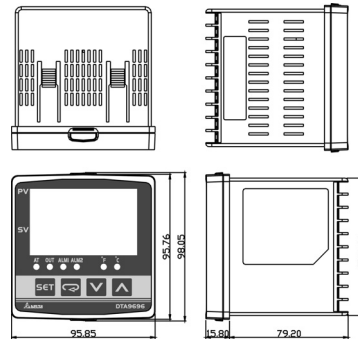
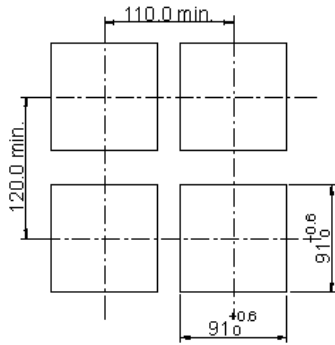

■ CT Wiring Method (if CT function is selected)

